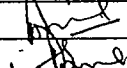
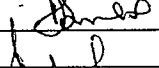
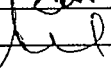
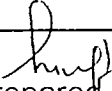

SCHEDULE	SCHEDULE OF INFRASTRUCTURAL REQUIREMENTS FOR MANUFACTURING & TESTING FOR SIDE BEARER TO DRAWING NO. CC11111	MDST: 36 Rev: NIL PAGE 1 OF 5
		Dated 12.12.2005

SCHEDULE OF INFRASTRUCTURAL REQUIREMENTS FOR MANUFACTURING & TESTING FOR SIDE BEARER

NAME	DESIGNATION	SIGNATURE	DATE	LEVEL
Harish Kumar	SSE/VD		12.12.05	Prepared
Joginder Singh	ADE/VD		12.12.05	Agreed
Amitabh Sinha	Dy. CME/TOT		14.12.05	Reviewed
S.K. Aggarwal	CDE		17.12.05	Approved

Issue/Rev	Details of Changes	Date

Prepared By

Agreed By

SCHEDULE	SCHEDULE OF INFRASTRUCTURAL REQUIREMENTS FOR MANUFACTURING & TESTING FOR SIDE BEARER TO DRAWING NO. CC11111	MDST: 36 Rev: NIL PAGE 2 OF 5
		Dated 12.12.2005

1.0 REQUIREMENTS

1. This schedule is applicable for side bearer to drawing no. CC11111. The vendors seeking approval shall comply with all the requirements mentioned below :

2.0 GENERAL & MANUFACTURING FACILITIES

- 2.1 Covered area with adequate space underneath for storage of raw materials e.g. billets, round corner squares, rounds etc. The covered area should have display board showing different colour shades nominated to different grades of steel to avoid mix up of materials. Arrangement of painting the billets, RCS rounds etc with particular paint shade previously nominated according to the grade of steel should be available.
- 2.2 At least 1 No. Fork-lift or 1 No. Over-head crane of 2t capacity shall be available for material handling.
- 2.3 Minimum 1 No. of band saw / billet shearing machine should be available.
- 2.4 At least 2 Nos. of drop hammer with minimum capacity of 3t or double acting pneumatic hammer / forging press of equivalent capacity along with at least 2 Nos. of trimming press of minimum capacity of 300t for removal of flash etc. shall be available.
- 2.5 Minimum 1 Nos. of compressors of 75 cfm minimum capacity each is to be installed. In addition, blower of minimum 5 HP should be available.
- 2.6 Minimum 1 Nos. of batch type oil fired or gas-fired or induction furnace of adequate capacity for heating cut pieces of billets/RCS/rounds etc. shall be available. The temperature range of these furnaces should be up to 1200°C and should be provided with automatic temperature controllers. The controller should be calibrated once in six month. The desired temperature shall be achieved within an accuracy of $\pm 10^{\circ}\text{C}$.
- 2.7 Minimum one number of pusher type oil fired/gas-fired/ induction furnace shall be available. The pusher type arrangement should be hydraulic / mechanical operated. The furnace should have adequate capacity to heat cut pieces of billets/RCS/rounds upto 1200°C temperature. The furnace should be provided with automatic temperature controllers. The controller should be calibrated once in six month. The desired temperature shall be achieved within an accuracy of $\pm 10^{\circ}\text{C}$.
- 2.8 2 Nos. of forced air circulation, pit type electric or equivalent tempering furnace of adequate capacity having automatic temperature controllers and recorders.
- 2.9 One shot blasting machine with table dia. of at least 3ft shall be available. The shot

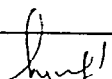
Prepared By

Agreed By

SCHEDULE	SCHEDULE OF INFRASTRUCTURAL REQUIREMENTS FOR MANUFACTURING & TESTING FOR SIDE BEARER TO DRAWING NO. CC11111	MDST: 36 Rev: NIL PAGE 3 OF 5
		Dated 12.12.2005

blasting machine shall have in-built facility of sieving undersize shots.

- 2.10 A die shop having adequate die sinking facilities comprising of spark erosion machines or alternative machine, capable of accommodating dies block up to 1t weight and 400mm height.
- 2.11 Adequate machining facilities comprising of vertical milling machine/radial drilling machines/horizontal lathes with tapping arrangements etc. of suitable capacities and standard makes are required for preparation of die blocks and machining of forged components.
- 2.12 Adequate Nos. of hand grinders is required for removal of fins & burrs.
- 2.13 Minimum 1 No. of honing machine of suitable capacity & standard make is required.
- 2.14 Prior to release of dies for production, it should be ensured that the dies are checked dimensionally in all respects including it's mounting on the forging hammer/press. The firm must list out the method of checking the dies i.e. either on plaster of Paris blocks or on auto-cad arrangement. Proper records of die inspection/checking showing the date of checking; important dimensions and contours must be maintained. Any ill effect of dies on forged components or their mismatching with forging hammers/press must be recorded. The remedial measures taken should also be documented.
- 2.15 It shall be ensured that critical inspection of the first forging and last forging of a production run is essentially carried out to ascertain behavior of the dies in operation and product quality.

3.0 TESTING FACILITIES

3.1 **Chemical Lab** : The firm must possess a fully equipped chemical lab with following facilities:

- Arrangement to carry out the analysis of C & S by Strohlein's apparatus and those of Si, P by conventional method shall be available.
- Metallurgical microscope of standard make having 1000 magnification to check inclusion content, grain size, microstructure, decarb etc.
- The firm should have permanent arrangement with NABL certified Lab or a reputed steel making company for arranging the spectro analysis of the material.
- The lab should possess facilities of making sulphur prints, hot etching for macro examination of materials.
- Muffle furnace with temp. range upto 1000°C.

3.2 **Physical Testing Lab**: The firm must possess a well equipped physical lab with

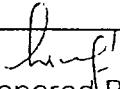
Prepared By

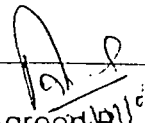
Agreed By

SCHEDULE	SCHEDULE OF INFRASTRUCTURAL REQUIREMENTS FOR MANUFACTURING & TESTING FOR SIDE BEARER TO DRAWING NO. CC11111	MDST: 36 Rev: NIL PAGE 4 OF 5
		Dated 12.12.2005

following facilities:

- Universal Testing machine of 40t capacity with load/ deflection plotting arrangement to conduct UTS, Yield strength and bending tests etc.
- BHN testing machine with necessary standard test pieces. The hardness testing machine shall have capacity to apply 3000 kgs load on one test specimen.

3.3 Non-destructive testing: The firm must possess the following NDT facilities:

- 1 No. Magnetic particle testing machine (wet method) with ultra violet light facilities s. The bed of the machine should be of adequate length to accommodate the full length of test pieces. The machine shall have arrangement for both longitudinal and circular magnetization. Magnetizing current capacity shall be appropriate to the work piece (1500 amps minimum).
- One number dye penetrant kit or ultrasonic testing machine for detection of surface cracks.
- One number surface roughness tester to measure the finish of honed surface.
- One number optical pyrometer to measure temp. ranging from 800°C to 1600°C.

3.4 Other Testing Facilities: The firm shall possess the following:

- The firm shall have adequate facilities for preparation of sample. Facilities like machining, grinding, polishing etc. should be available in house.
- Adequate number of fine punches for stamping marking particulars on finished components.
- Adequate numbers measuring instruments such as:
 - Vernier Calipers – 0 to 600 mm
 - Measuring scales – 1 meter
 - Micrometers - Ranging from 0 to 150 mm
 - GO & NO-GO gauges
 - Surface plate
 - Vernier height gauge.

4.0. QUALITY CONTROL REQUIREMENTS

4.1 There should be a system to ensure the traceability of the product from raw material stage to finished product stage. This system should also facilitate to identify the raw material composition from the finish product stage.

4.2 Ensure that there is a QAP for the product detailing various aspects: -

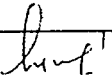

Prepared By

Agreed By
12/12/05

SCHEDULE	SCHEDULE OF INFRASTRUCTURAL REQUIREMENTS FOR MANUFACTURING & TESTING FOR SIDE BEARER TO DRAWING NO. CC11111	MDST: 36 Rev: NIL PAGE 5 OF 5
		Dated 12.12.2005

- QA Organisational Chart
- Flow Process Chart
- Stage inspection details
- Various parameters and to ensure control over them

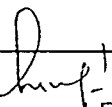
- 4.3 There should be at least one full time technologist having a minimum bachelor's degree in relevant field & 5 years experience or a person with diploma in relevant field with 12 years experience. He should be free from day-to-day production, testing and quality control responsibilities. He should be mainly responsible for development of a product, analysis of products, control over raw material, and corrective action in case of difficulties in achieving the parameters.
- 4.4 The firm should have acquired ISO: 9000 series certification and the product for which an approval is sought should be broadly covered in the scope of the certification for manufacture and supply.
- 4.5 The Quality manual of the firm for ISO: 9000 should clearly indicate at any stage the control over manufacturing and testing of the said railway product.
- 4.6 The firm shall ensure that proper analysis is being done on monthly basis to study the rejection at various internal stages and it is documented.
- 4.7 The firm shall ensure that all the relevant specifications, IS standards are available with them.

Prepared By

Agreed By

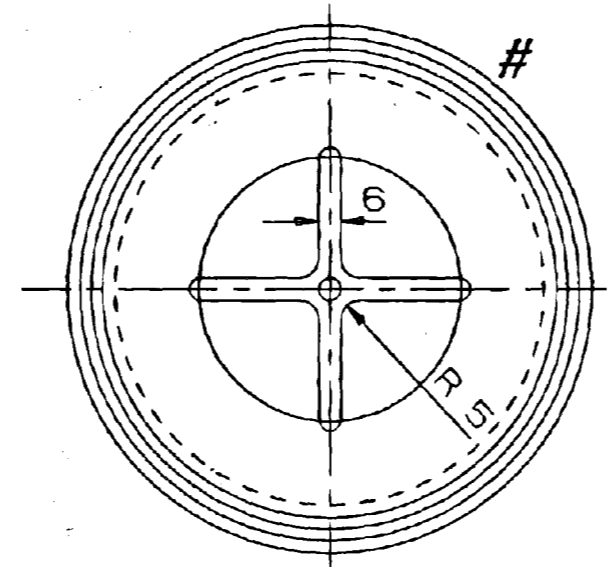
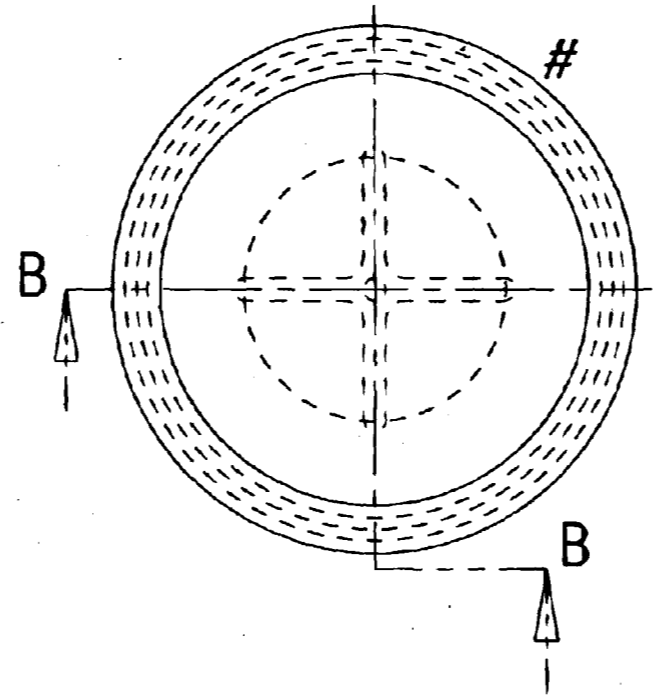
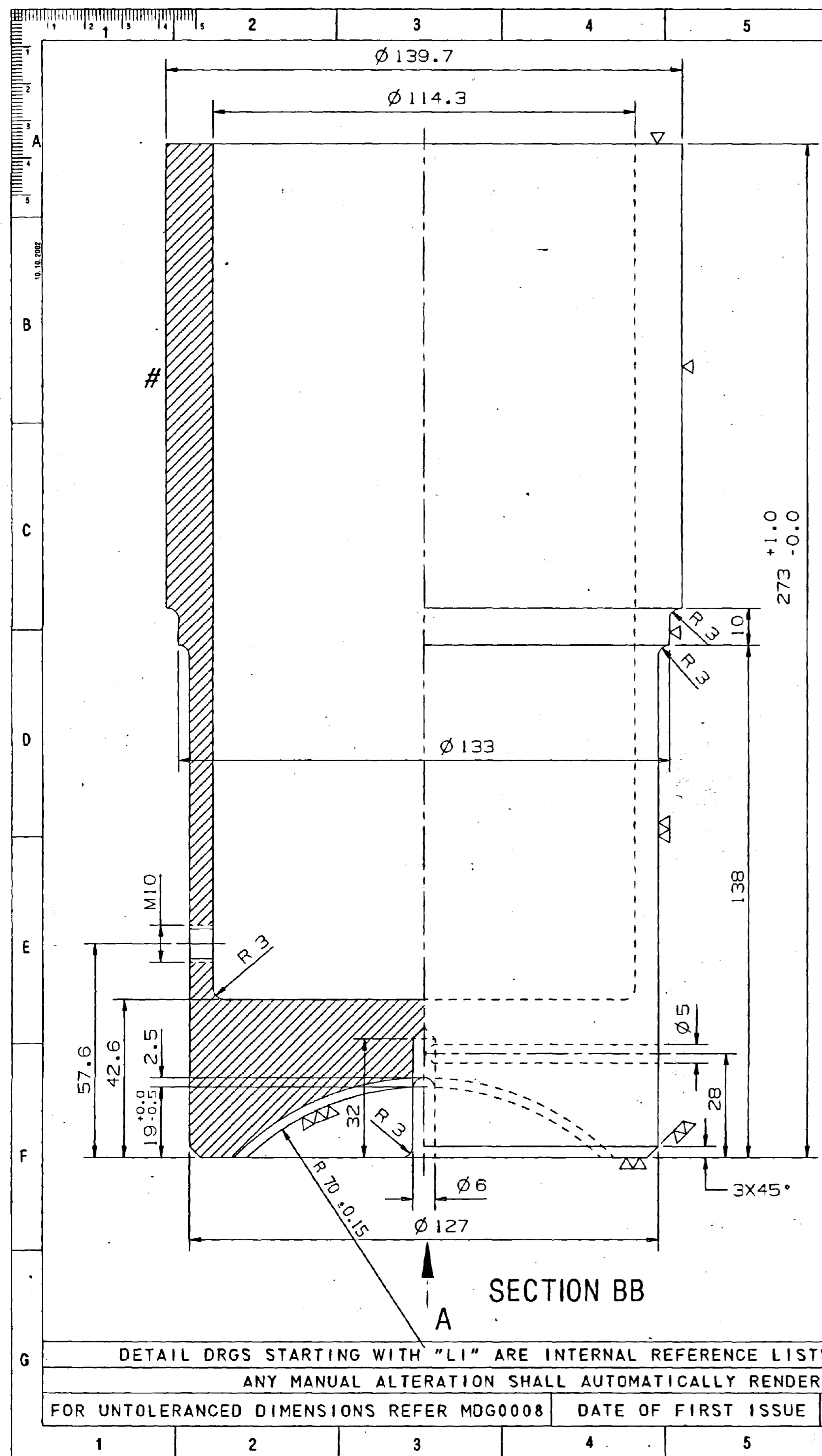

VIEW FROM 'A'

ALT. NO	ALT. DATE	ZONE	ALTERATIONS	AUTHORITY
a	29/06/96	NIL F12 F12 B5 C5 F1	1: DRAWING FORMAT REVISED. 2: MAT. SPEC. YEAR UPDATED. 3: RAW MATERIAL SIZE 139.7 WAS 139.5. 4: DIMENSION 125 DELETED. 5: DIM. 273 ± 0.0 ADDED. 6: DIM. 19 ± 0.5 WAS 19.	DIC NO. MD960176
b	01/06/98	NIL	1: NOTE-1 ADDED.	DIC NO. MD980167
c	16/06/2000	C-5	1. TOLERANCE ON DIM. 273 WAS ± 0.0	DIC NO. MD000143
d	09/12/2000	F.3 B.7	1. DIM. R70 ± 0.15 WAS R70. 2. TOP VIEW ADDED.	DIC NO. MD000222
e	18/05/2003	E-10	1. NOTE-2 & 3 ADDED	DIC NO MD030130

20 MAY 2003

- NOTE:
1. MANUFACTURER'S INITIAL, MONTH AND YEAR SHALL BE STAMPED AT # IN LETTER HEIGHT = 6MM.
 2. HEAT TREATMENT:-FORGED & MACHINED SIDE BEARER TUBE SHALL BE NORMALISED
 3. PROTECTION :-PROVIDE PROTECTION AS PER RCF PROTECTION PROCEDURE NO WI100160.

WELD LENGTH	ITEM	DESCRIPTION & DIMENSIONS	ASSEMBLY	DETAIL DRG	MATL. & SPEC.	REMARKS
NIL	M	GROUP UNDERFRAME	SUPERSEDES: CC11111 ALT d			
WEIGHT	FILE	/USERS2/SHELL/UFRM/CC11111e.PRT				
11.000	KG	SIDE BEARER		SCALE	SSE/REC	<i>[Signature]</i>
S.AREA				1:1	CHD	<i>[Signature]</i>
NIL	M ²				DRN	<i>[Signature]</i>
LENGTH / DIA		RAIL COACH FACTORY, KAPUR THALA		REF.DRG.No.	CC11111, ALT-d	
0.1397	M	INDIAN RAILWAYS STANDARD		PL NO.	00770437	
WIDTH / THICK				DRG.NO.	CC11111	
0.0127	M			ALT.	e	SIZE A2 SHEET 1/1
HEIGHT				CDE		
0.273	M					

DETAIL DRGS STARTING WITH "LI" ARE INTERNAL REFERENCE LISTS ONLY AND ARE NOT FOR ISSUE

ANY MANUAL ALTERATION SHALL AUTOMATICALLY RENDER THIS DRAWING INVALID.

FOR UNTOLERANCED DIMENSIONS REFER MDG0008 DATE OF FIRST ISSUE 25/06/1992 CGM BY *[Signature]*