

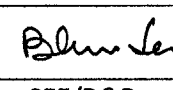

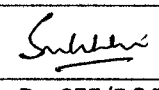

EDML-205 for Set of Modular type Switch Plate Assemblies for LHB AC RA Coach to DRG.No LW74005 Alt - 'Nil'								
S. No.	SW/Socket	Item	Marking	Module	Total Module	QPC	Remarks/ Location	Dr. No.
1	Switch	SW-16A	16A	2	4	7	Kitchen Area	LW74005 Alt- 'Nil' ITEM-1
	Socket	PS-16A	PS 16A, 220V	2				
2	Switch	LED-(DL)	DL	1	4	1	Kitchen Area	LW74005 Alt- 'Nil' ITEM-2
	Switch	LED-(L)	L	1				
	Switch	LED-DL	DL	1				
	Switch	LED-DNL	DNL	1				
3	Switch	LED-(L)	L	1	14 i.e. 7+7	1	Attendant Room	LW74005 Alt- 'Nil' ITEM-3
	Switch	LED-(DL)	DL	1				
	Switch	LED-(DNL)	DNL	1				
	Switch	SP	SPARE	1				
	Switch	SW-CS1	CS	1				
	Socket	CS-1	CS 110V	2				
	Socket	CS-2	CS 110V	2				
	Switch	SW-CS2	CS	1				
	Switch	SP	SPARE	1				
	Switch	SW-CS3	CS	1				
4	Switch	LED(LL1)	LL1	1	3	1	Steno & Attendant Lavatory	LW74005 Alt- 'Nil' ITEM-4
	Switch	LED (LL2)	LL2	1				
	Switch	FAN	F	1				
5	Switch	SW-16A	16A	2	4	1		LW74005 Alt- 'Nil' ITEM-1
	Socket	SW-GEYSER	GY 16A	2				
6	Switch	CALL BELL	CB	1	14 i.e. 7+7	1	Steno Room	LW74005 Alt- 'Nil' ITEM-5
	Switch	LED-(L)	L	1				
	Switch	LED-DL	DL	1				
	Switch	LED-(DNL)	DNL	1				
	Switch	Fan	F	1				
	Switch	LV1	LV1	1				
	Switch	LV2	LV2	1				
	Socket	CS-1	CS 110V	2				
	Switch	SW-CS1	CS	1				
	Switch	SP	SPARE	1				
	Switch	SW-CS2	CS	1				
	Socket	CS-2	CS 110V	2				

EDML-205	NIL	01/09/23				1 of 5
Doc. No.	Rev.	Date	SSE/CAD	SEE/D&D	Dy.CEE/D&D	Page

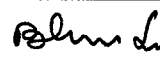

7	Switch	SW-PS	PS	1	6	2		LW74005 Alt- 'Nil' ITEM-6
	Socket	PS	PS 230V	2				
	Switch	SW-PS	PS	1				
	Socket	PS	PS 230V	2				
8	Switch	LED-(DCL1)	DCL-1	1	14 i.e. 7+7	1	Lounge Room	LW74005 Alt- 'Nil' ITEM-7
	Switch	LED-(L)	L	1				
	Switch	LED-(L)	L	1				
	Switch	LED-(L)	L	1				
	Switch	LED-(L)	L	1				
	Switch	LED-(DL)	DL	1				
	Switch	LED-(DNL)	DNL	1				
	Switch	LED-(DCL2)	DCL2	1				
	Switch	LED-(IND)	IND	1				
	Switch	LED-(DL)	DL	1				
	Switch	LED-(DNL)	DNL	1				
	Socket	CS	CS 110V	2				
9	Switch	SW-CS	CS	1	6	1	Lounge Room (Side wall side)	LW74005 Alt- 'Nil' ITEM-6
	Socket	CS	CS 110V	2				
	Switch	SW-CS	CS	1				
	Socket	CS	CS 110V	2				
10	Switch	LED-(FL) 1 & 2	FL 1 & 2	1	6	1	Lounge Room (Partition wall) Corner table side	LW74005 Alt- 'Nil' ITEM-8
	Switch	LED-(DCL)	DCL	1				
	Switch	LED-(DCL)	DCL	1				
	Switch	LED-(FL)	FL	1				
	Switch	LED-(FL)	FL	1				
	Switch	CALL BELL	CB	1				
11	Switch	SW-PS	PS	1	6	1	Lounge Room (Partition wall Door Side)	LW74005 Alt- 'Nil' ITEM-6
	Socket	PS	PS 230V	2				
	Switch	SW-PS	PS	1				
	Socket	PS	PS 230V	2				
12	Socket	CS	CS 110V	2	5	1	Master Bedroom (Partition Lounge Room side)	LW74005 Alt- 'Nil' ITEM-12
	Switch	SW-CS	CS	1				
	Switch	FAN	F	1				
	Switch	CALL BELL	CB	1				

EDML-205	NIL	01/09/23				2 of 5
Doc. No.	Rev.	Date	SSE/CAD	SEE/D&D	Dy.CEE/D&D	Page

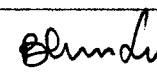
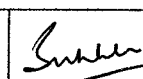
13	Socket	CS	CS 110V	2	5	1		LW74005 Alt- 'Nil' ITEM-9
	Switch	SW-CS	CS	1				
	Switch	LED-(DL)	DL1 & DL2	1				
	Switch	LED-(DNL)	DNL	1				
14	Switch	LED-(FL)	FL	1	7	1	Master Bedroom side wall	LW74005 Alt- 'Nil' ITEM-10
	Switch	SW-PS	PS	1				
	Socket	PS	PS 230V	2				
	Switch	SW-PS	PS	1				
	Socket	PS	PS 230V	2				
15	Switch	LED(LL1)	LL1	1	3	1	Master Bedroom side wall Lav. Partition	LW74005 Alt- 'Nil' ITEM-4
	Switch	LED(LL1)	LL2	1				
	Switch	FAN	F	1				
16	Switch	LED-(DCL)	DCL	1	5	1	Master Bedroom Entry Side Door	LW74005 Alt- 'Nil' ITEM-11
	Switch	LED-(L)	L	1				
	Switch	LED-(IND)	IND	1				
	Switch	LED-(L)	L	1				
	Switch	LED-(DCL)	DCL	1				
17	Switch	LED-(DL)	DL	1	5	1	Master Bedroom (Entry side Door)	LW74005 Alt- 'Nil' ITEM-11
	Switch	LED-(DNL)	DNL	1				
	Switch	LED-(DL)	DL	1				
	Switch	SPARE	SP	1				
	Switch	SPARE	SP	1				
18	Socket	CS (SHAVER SOCKET)	CS 110V	2	3	1	Master Bedroom lav.	LW74005 Alt- 'Nil' ITEM-13
	Switch	SW-CS	CS	1				
19	Switch	SW-16A	16A	2	4	1		LW74005 Alt- 'Nil' ITEM-1
	Socket	GEYSER	GY 16A	2				
20	Socket	CS (SHAVER SOCKET)	CS 110V	2	3	1	Guest Room Lav. Area	LW74005 Alt- 'Nil' ITEM-13
	Switch	SW-CS	CS	1				
21	Switch	SW-16A	16A	2	4	1		LW74005 Alt- 'Nil' ITEM-1
	Socket	GEYSER	GY 16A	2				
22	Switch	LL1	LL1	1	3	1	Guest Room (Lav. Wall)	LW74005 Alt- 'Nil' ITEM-4
	Switch	FAN	F	1				
	Switch	LL2	LL2	1				

EDML-205	NIL	01.09.23				3 of 5
Doc. No.	Rev.	Date	SSE/CAD	SEE/D&D	Dy.CEE/D&D	Page

23	Socket	PS	PS 230V	2	7	1	Guest Room (Side Wall Lav. Side)	LW74005 Alt- 'Nil' ITEM-16
	Switch	SW-PS	PS	1				
	Socket	PS	PS 230V	2				
	Switch	SW-PS	PS	1				
	Switch	CALL BELL	CB	1				
24	Switch	SW-CS	CS	1	6	1	Guest Room (Wall observation Side)	LW74005 Alt- 'Nil' ITEM-6
	Socket	CS	CS 110V	2				
	Switch	SW-CS	CS	1				
	Socket	CS	CS 110V	2				
25	Switch	LED (L)	L	1	5	1	Guest Room (Partition wall entrance Door)	LW74005 Alt- 'Nil' ITEM-11
	Switch	LED (DL 1 &2)	DL	1				
	Switch	LED (DNL)	DNL	1				
	Switch	LED (L)	L	1				
	Switch	LED(FL)	FL	1				
26	Switch	SW-PS	PS	1	6	2	IT ROOM	LW74005 Alt- 'Nil' ITEM-6
	Socket	PS	PS 230V	2				
	Switch	SW-PS	PS	1				
	Socket	PS	PS 230V	2				
27	Socket	CS	CS 110V	2	14 i.e. 7x2	2	Observation Room 1 & 2	LW74005 Alt- 'Nil' ITEM-14
	Switch	SW-CS	CS	1				
	Switch	LED SL-1	SL	1				
	Switch	LED SL-2	SL	1				
	Switch	LED SL-3	SL	1				
	Switch	LED L	L	1				
	Socket	PS	PS 230V	2				
	Switch	SW-PS	PS	1				
	Switch	FAN	F	1				
	Socket	PS	PS 230V	2				
	Switch	SW-PS	PS	1				

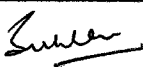
EDML-205	NIL	01/09/23				4 of 5
Doc. No.	Rev.	Date	SSE/CAD	SEE/D&D	Dy.CEE/D&D	Page

28	Socket	CS	CS 110V	2	14 i.e. 7x2	2	Observation Room 1 & 2	LW74005 Alt- 'Nil' ITEM-15
	Switch	SW-CS	CS	1				
	Switch	LED L	L	1				
	Switch	LED DL	DL	1				
	Switch	LED DNL	DNL	1				
	Switch	CALL BELL	CB	1				
	Socket	PS	PS 230V	2				
	Switch	SW-PS	PS	1				
	Switch	FAN	F	1				
	Socket	PS	PS 230V	2				
	Switch	SW-PS	PS	1				
29	Switch	LED DL	DL	1	4	2	Corridor area (Master & Guest Room)	LW74005 Alt- 'Nil' ITEM-2
	Switch	LED DNL	DNL	1				
	Switch	LED FL	FL	1				
	Switch	LED DL	DL	1				
30	Switch	LED DL	DL	1	4	1	Corridor area (Steno & Attendant room)	LW74005 Alt- 'Nil' ITEM-2
	Switch	LED DNL	DL	1				
	Switch	LED DL	DNL	1				
	Switch	LED DL	DL	1				

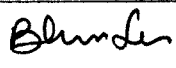
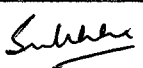
EDML-205	NIL	01.09.23				5 of 5
Doc. No.	Rev.	Date	SSE/CAD	SEE/D&D	Dy.CEE/D&D	Page

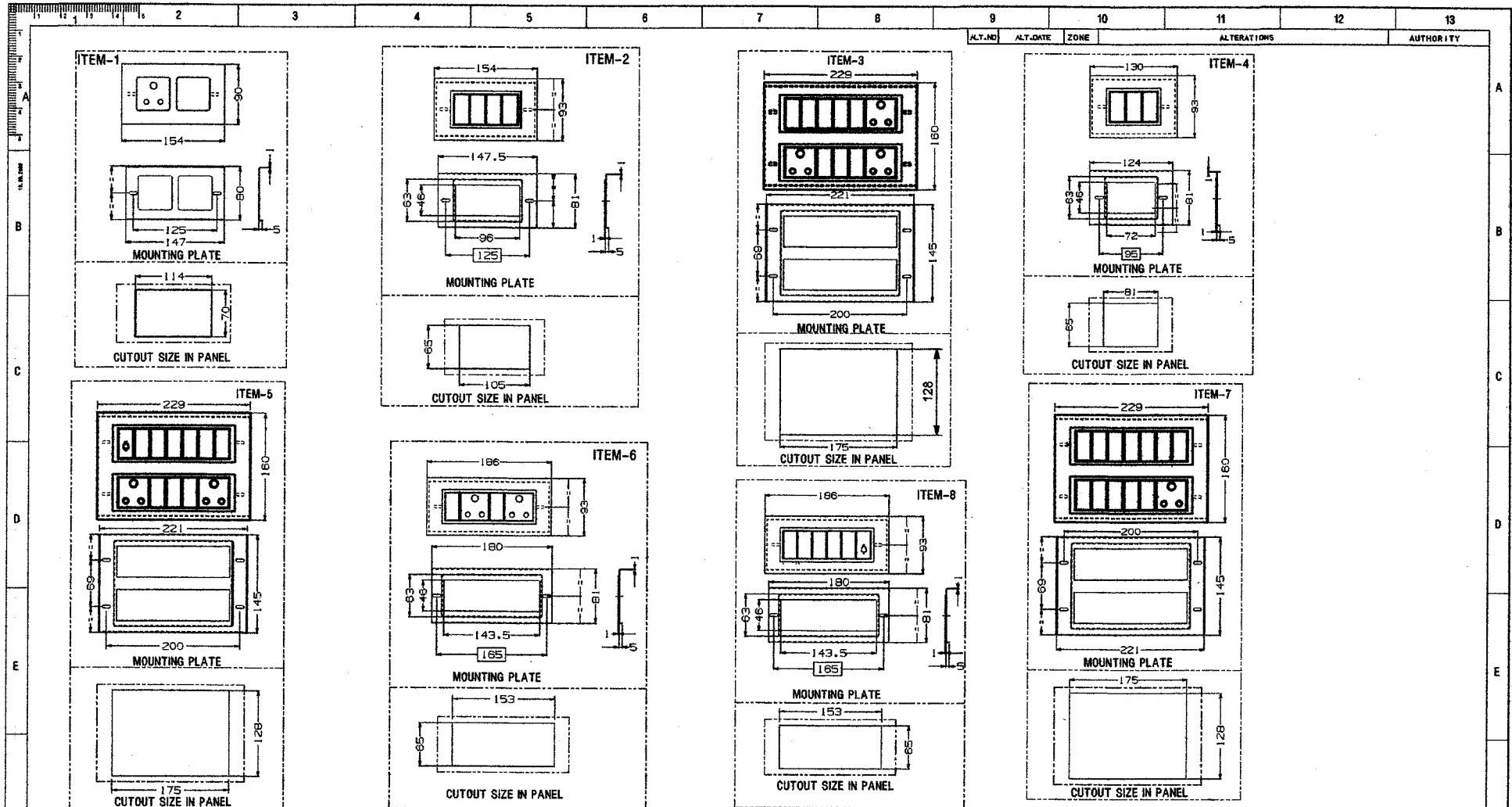

ALT. NO.	ALT. DATE	ZONE	ALTERATIONS	AUTHORITY																																																																																						
<table border="1"> <tr> <td>WELD LENGTH</td> <td>ITEM</td> <td>DESCRIPTION & DIMENSIONS</td> <td>OPASSLY</td> <td>DETAIL DRG</td> <td>MATL. & SPEC.</td> <td>REMARKS</td> </tr> <tr> <td>NIL</td> <td>M</td> <td>ELECTRICAL</td> <td></td> <td></td> <td></td> <td></td> </tr> <tr> <td>WEIGHT</td> <td>FILE</td> <td colspan="4">C:\Users\U360841\Desktop\LW74005 s1 (1).prt</td> </tr> <tr> <td>NIL</td> <td>KG</td> <td colspan="4">REFERENCE DIAGRAM FOR</td> </tr> <tr> <td>S. AREA</td> <td>M²</td> <td colspan="4">SWITCH PLATES FOR LHB AC RA COACH</td> </tr> <tr> <td>LENGTH</td> <td>M</td> <td colspan="4">RAIL COACH FACTORY, KAPURTHALA</td> </tr> <tr> <td>NIL</td> <td>M</td> <td colspan="4">रेल कोच फैक्टरी कपूरथला</td> </tr> <tr> <td>WEIGHT</td> <td>M</td> <td>IR S</td> <td>SCALE</td> <td>SSE/ED</td> <td>CHKD</td> <td>DRN</td> </tr> <tr> <td>NIL</td> <td>M</td> <td></td> <td></td> <td></td> <td></td> <td></td> </tr> <tr> <td>HEIGHT</td> <td>M</td> <td>DRN</td> <td>REF. DRG.</td> <td>NIL</td> <td>PL NO.</td> <td>NIL</td> </tr> <tr> <td>NIL</td> <td>M</td> <td>SEE/D&D</td> <td>DRY.CEE/D&D</td> <td></td> <td>DRG. NO.</td> <td>LW74005</td> </tr> <tr> <td></td> <td></td> <td></td> <td></td> <td></td> <td>ALT.</td> <td>NIL</td> </tr> <tr> <td></td> <td></td> <td></td> <td></td> <td></td> <td>SIZE</td> <td>A2 SHEET 1/2</td> </tr> </table>					WELD LENGTH	ITEM	DESCRIPTION & DIMENSIONS	OPASSLY	DETAIL DRG	MATL. & SPEC.	REMARKS	NIL	M	ELECTRICAL					WEIGHT	FILE	C:\Users\U360841\Desktop\LW74005 s1 (1).prt				NIL	KG	REFERENCE DIAGRAM FOR				S. AREA	M ²	SWITCH PLATES FOR LHB AC RA COACH				LENGTH	M	RAIL COACH FACTORY, KAPURTHALA				NIL	M	रेल कोच फैक्टरी कपूरथला				WEIGHT	M	IR S	SCALE	SSE/ED	CHKD	DRN	NIL	M						HEIGHT	M	DRN	REF. DRG.	NIL	PL NO.	NIL	NIL	M	SEE/D&D	DRY.CEE/D&D		DRG. NO.	LW74005						ALT.	NIL						SIZE	A2 SHEET 1/2
WELD LENGTH	ITEM	DESCRIPTION & DIMENSIONS	OPASSLY	DETAIL DRG	MATL. & SPEC.	REMARKS																																																																																				
NIL	M	ELECTRICAL																																																																																								
WEIGHT	FILE	C:\Users\U360841\Desktop\LW74005 s1 (1).prt																																																																																								
NIL	KG	REFERENCE DIAGRAM FOR																																																																																								
S. AREA	M ²	SWITCH PLATES FOR LHB AC RA COACH																																																																																								
LENGTH	M	RAIL COACH FACTORY, KAPURTHALA																																																																																								
NIL	M	रेल कोच फैक्टरी कपूरथला																																																																																								
WEIGHT	M	IR S	SCALE	SSE/ED	CHKD	DRN																																																																																				
NIL	M																																																																																									
HEIGHT	M	DRN	REF. DRG.	NIL	PL NO.	NIL																																																																																				
NIL	M	SEE/D&D	DRY.CEE/D&D		DRG. NO.	LW74005																																																																																				
					ALT.	NIL																																																																																				
					SIZE	A2 SHEET 1/2																																																																																				
G DETAIL DRGS STARTING WITH "LI" ARE INTERNAL REFERENCE LISTS ONLY AND ARE NOT FOR ISSUE ANY MANUAL ALTERATION SHALL AUTOMATICALLY RENDER THIS DRAWING INVALID.																																																																																										
FOR UNTOLERANCED DIMENSIONS REFER MDG0008 DATE OF FIRST ISSUE 20/08/2023																																																																																										

1	2	3	4	5	6	7	8	9	10	11	12	13
---	---	---	---	---	---	---	---	---	----	----	----	----

ALT.NO	ALT.DATE	ZONE	ALTERATIONS	AUTHORITY
--------	----------	------	-------------	-----------

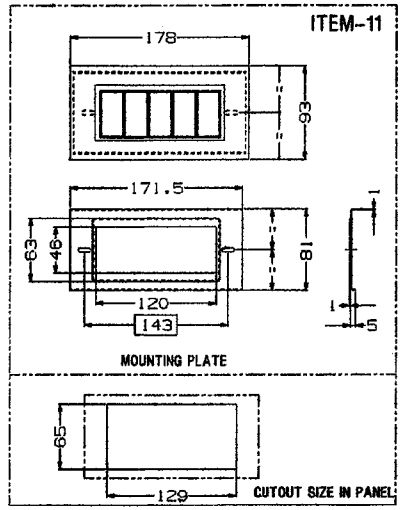
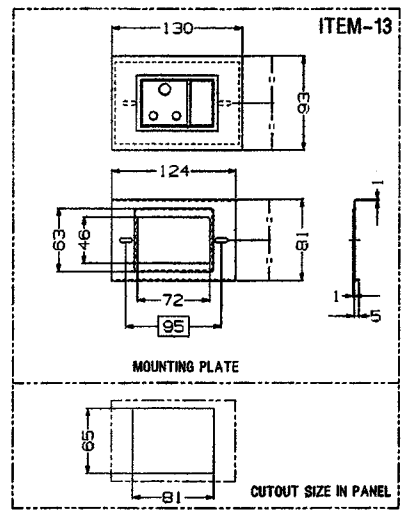
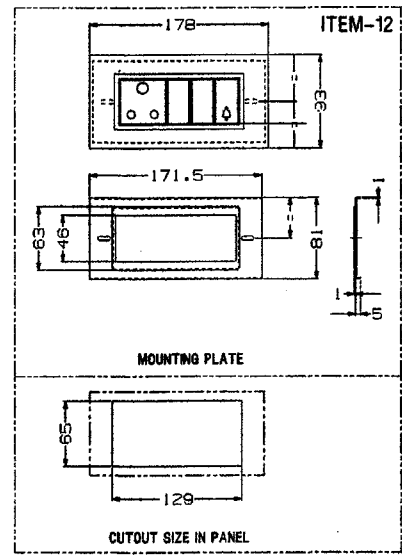
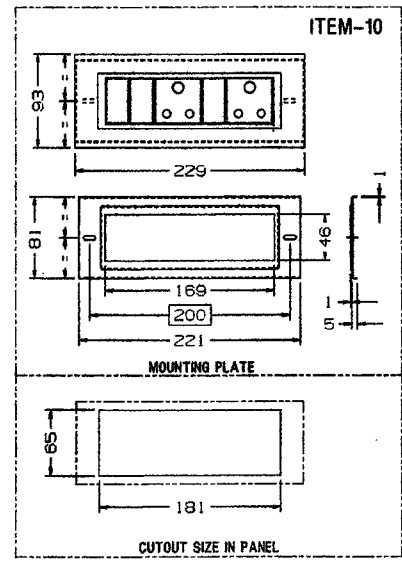
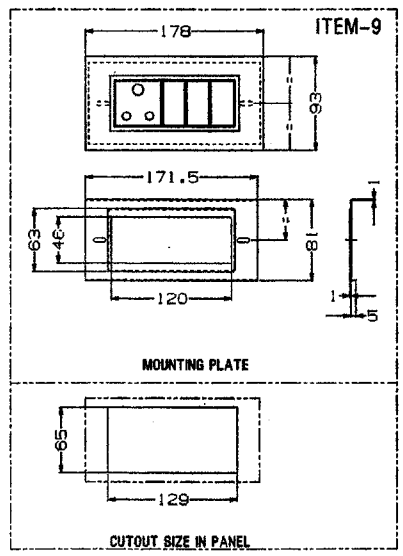

DETAIL DRGS STARTING WITH "LI" ARE INTERNAL REFERENCE LISTS ONLY AND ARE NOT FOR ISSUE
 ANY MANUAL ALTERATION SHALL AUTOMATICALLY RENDER THIS DRAWING INVALID.

FOR UNTOLERANCED DIMENSIONS REFER MDG0008 DATE OF FIRST ISSUE 28/08/2023

WELD LENGTH	ITEM	DESCRIPTION & DIMENSIONS	GROUP	DETAIL DRG	MATL. & SPEC.	REMARKS
NIL	M	ELECTRICAL				
WEIGHT	FILE	C:\Users\U360841\Desktop\LW74005 s1 (2).prt				
NIL	KG	REFERENCE DIAGRAM FOR				
S.AREA	M2	SWITCH PLATES FOR LHB AC RA COACH				
NIL	M	RAIL COACH FACTORY, KAPURTHALA				
SCALE	SSE/ED	DR				
NIL	M	REL कोच फैक्टरी कपूरथला				
IR	PL NO.	NIL				
NIL	M	DRG.NO. LW74005				
HEIGHT	ALT.	NIL				
NIL	M	SIZE A2 SHEET 2/3				

1	2	3	4	5	6	7	8	9	10	11	12	13
---	---	---	---	---	---	---	---	---	----	----	----	----

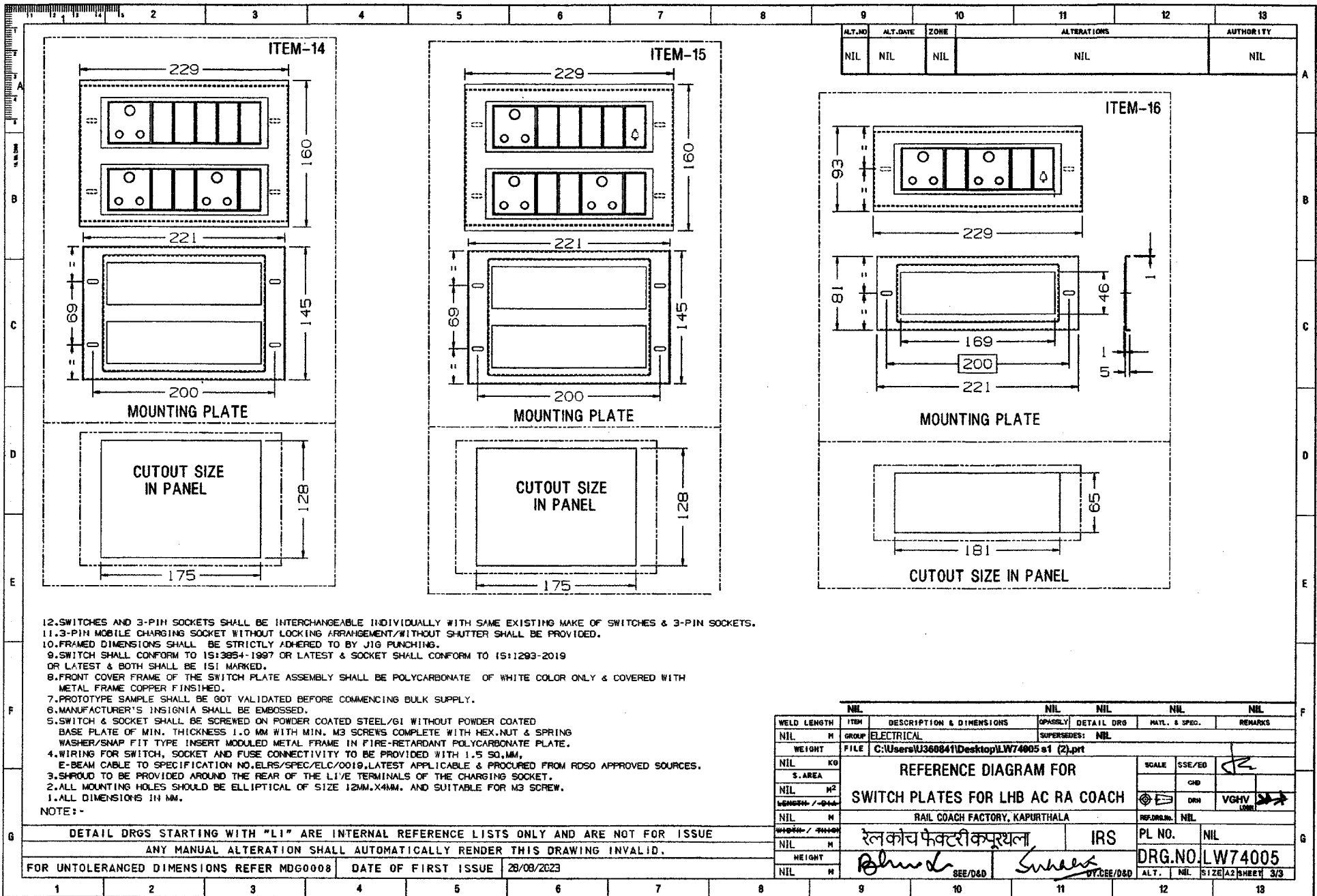

- 12. SWITCHES AND 3-PIN SOCKETS SHALL BE INTERCHANGEABLE INDIVIDUALLY WITH SAME EXISTING MAKE OF SWITCHES & 3-PIN SOCKETS.
- 11. 3-PIN MOBILE CHARGING SOCKET WITHOUT LOCKING ARRANGEMENT/WITHOUT SHUTTER SHALL BE PROVIDED.
- 10. FRAMED DIMENSIONS SHALL BE STRICTLY ADHERED TO BY JIG PUNCHING.
- 9. SWITCH SHALL CONFORM TO IS:3854-1997 OR LATEST & SOCKET SHALL CONFORM TO IS:1293-2019 OR LATEST & BOTH SHALL BE ISI MARKED.
- 8. FRONT COVER FRAME OF THE SWITCH PLATE ASSEMBLY SHALL BE POLYCARBONATE OF WHITE COLOR ONLY & COVERED WITH METAL FRAME COPPER FINISHED.
- 7. PROTOTYPE SAMPLE SHALL BE GOT VALIDATED BEFORE COMMENCING BULK SUPPLY.
- 6. MANUFACTURER'S INSIGNIA SHALL BE EMBOSSED.
- 5. SWITCH & SOCKET SHALL BE SCREWED ON POWDER COATED STEEL/GI WITHOUT POWDER COATED BASE PLATE OF MIN. THICKNESS 1.0 MM WITH MIN. M3 SCREWS COMPLETE WITH HEX.NUT & SPRING WASHER/SNAP FIT TYPE INSERT MODULED METAL FRAME IN FIRE-RETARDANT POLYCARBONATE PLATE.
- 4. WIRING FOR SWITCH, SOCKET AND FUSE CONNECTIVITY TO BE PROVIDED WITH 1.5 SQ.MM, E-BEAM CABLE TO SPECIFICATION NO.ELRS/SPEC/ELC/0019, LATEST APPLICABLE & PROCURED FROM RDSO APPROVED SOURCES.
- 3. SHROUD TO BE PROVIDED AROUND THE REAR OF THE LIVE TERMINALS OF THE CHARGING SOCKET.
- 2. ALL MOUNTING HOLES SHOULD BE ELLIPTICAL OF SIZE 12MM.X4MM. AND SUITABLE FOR M3 SCREW.
- 1. ALL DIMENSIONS IN MM.

NOTE:-

DETAIL DRGS STARTING WITH "L1" ARE INTERNAL REFERENCE LISTS ONLY AND ARE NOT FOR ISSUE
 ANY MANUAL ALTERATION SHALL AUTOMATICALLY RENDER THIS DRAWING INVALID.
 FOR UNTOLERANCED DIMENSIONS REFER MDG0008 DATE OF FIRST ISSUE 28/08/2023

NIL		NIL		NIL		NIL		NIL			
WELD LENGTH	ITEM	DESCRIPTION & DIMENSIONS	OPASSLY	DETAIL DRG	MATL. & SPEC.	REMARKS					
NIL	M	ELECTRICAL	SUPERSEDES: NIL								
WEIGHT	FILE	C:\Users\U360841\Desktop\LW74005 s1 (2).prt									
NIL	KG	REFERENCE DIAGRAM FOR		SCALE	SSE/ED						
S. AREA	M2	SWITCH PLATES FOR LHB AC RA COACH			CHD						
LENGTH	M	RAIL COACH FACTORY, KAPURTHALA		REF.DWG. NO.	NIL						
NIL	M	रेल कोच फैक्टरी कपूरथला		IRIS	PL NO.	NIL					
WEIGHT	M			DRG. NO.	LW74005						
NIL	M	SEE/D&D		DT. CEE/D&D	ALT.	NIL	SIZE	A2	SHEET	3/3	